

IKO

PRECISION LINEAR SLIDE

BSP·BSPG·BSR

PATENTED

Smallest size in BSR series newly introduced !



CAT-5782A

Extremely small, light weight and

Low sectional height with thin special-steel plate made type in BSR series



compact !!

are newly introduced !

IKO PRECISION LINEAR SLIDE
BSP·BSPG·BSR



Smallest size

Limited linear motion type

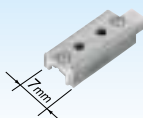

< BSP 7 >

Built-in rack & pinion type



< BSPG 12 >

Endless linear motion type

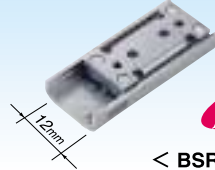

NEW!

< BSR 12 >

IJKO PRECISION LINEAR SLIDE

BSP • BSPG • BSR

IJKO Precision Linear Slide series is a light weight and compact linear motion rolling guide, comprising a U-shaped table and bed or track rail made from stainless steel sheet by precision forming. The raceway grooves are accurately ground on the table and bed or track rail. IJKO Precision Linear Slide series features high performance and durability, making this series suitable for measuring equipment, IC manufacturing and inspection devices, etc. This series has also been successfully used as a precision linear motion guide of read/write head of hard disk drives.

IJKO Precision Linear Slide series is available three different types of a Limited linear motion BSP series, Built-in rack & pinion BSPG series, and Endless linear motion BSR series for selections suitable for each application.

U.S. PATENT No. 5,076,715
 No. 4,799,302
 No. 4,701,059
 No. 4,701,057
 No. 4,654,940
 No. 4,647,226
 No. 4,593,957

Precision Linear Slide BSP

[Non-recirculating ball type]

A special synthetic resin retainer is used to hold the balls and eliminate ball contact noise. Extremely smooth and light movement without stick slips is obtained in a limited stroke length.

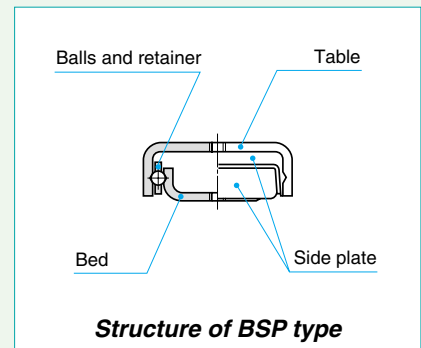

Precision Linear Slide BSPG

[Non-recirculating ball/with rack & pinion type]

The one-piece retainer in this type holds the balls in both rows. A pinion gear assembled in the retainer engages with rack gears fixed on the table and bed to prevent drifting movement of the retainer in relation to the table and bed. The BSPG type has the same extremely smooth movement as the BSP type.

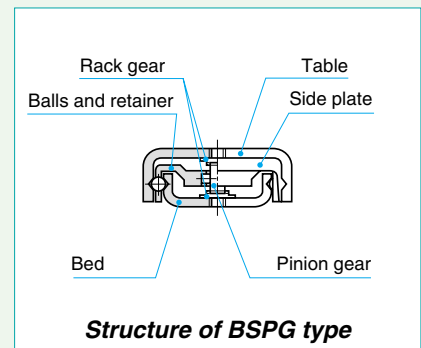

Precision Linear Slide BSR

[Recirculating ball type]

This type features a special synthetic resin circulator to recirculate the balls, permitting longer stroke lengths with low noise. For track rails over the lengths shown in the dimension table, please consult IJKO.

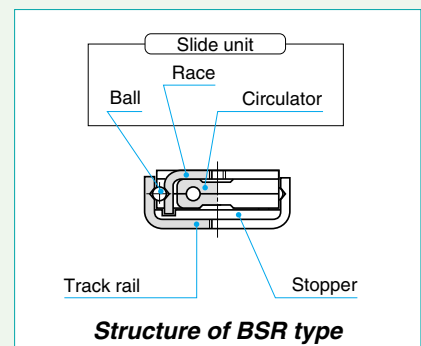

Features of Precision Linear Slide series

1 Superior Corrosion Resistance

The balls and raceways are made of stainless steel, superior in corrosion resistance and suitable for use in clean rooms.

2 Light weight and Compact

A simple structural design minimizes the number of components, offering reduced size and weight of sliding members in machines and equipment.

3 Smooth and Quiet Motion

The advanced design of ball retainers and circulators combined with precisely ground raceways minimizes noise and gives smooth motion with low frictional resistance. Thus, superior positioning accuracy and response can be obtained during operation even for a very small feed motion.

4 High Accuracy and Stable Performance

The steel balls are arranged in two rows with each ball contacting the raceways at four points. Thus, this series can withstand loads in every direction. In addition, the simple design minimizes errors in manufacturing and assembly, ensuring high operating accuracy.

5 High safety

All organic components are made of nonflammable or self-extinguishing materials. Thus, this series may be used in home appliances and office equipment.

6 Contaminant-Free Quality Control

Contaminant-free assembly and packaging for computer and clean room applications are available on request.

IKO Abundant Series and Size variations

	Series	Model code	Width (mm)	Length (mm)															
				15	20	25	30	35	40	45	50	60	70	80	100				
Precision Linear Slide	Limited linear motion type	BSP...SL	7	●	●		●		●										
			10			●		●		●									
			15				●		●		●	●							
			20						●		●	●	●	●	●	●			
			25								●	●	●	●	●	●	●	●	●
	Built-in rack & pinion type	BSPG...SL	12			●		●		●									
			15					●		●	●								
			20						●		●	●	●	●	●	●	●	●	●
			25								●	●	●	●	●	●	●	●	●
	Endless linear motion type	BSR...SL	12					NEW		NEW		NEW	NEW						
			15				●		●		●	●							
			20						●		●	●	●	●	●	●	●	●	●
25													●	●	●	●	●	●	

1N=0.102kgf=0.2248lbs.
1mm=0.001m=0.03937inch

Identification number and specification

The specification of Precision Linear Slide is indicated by the identification number, consisting of a model code, a size, a material symbol, and a clearance symbol.

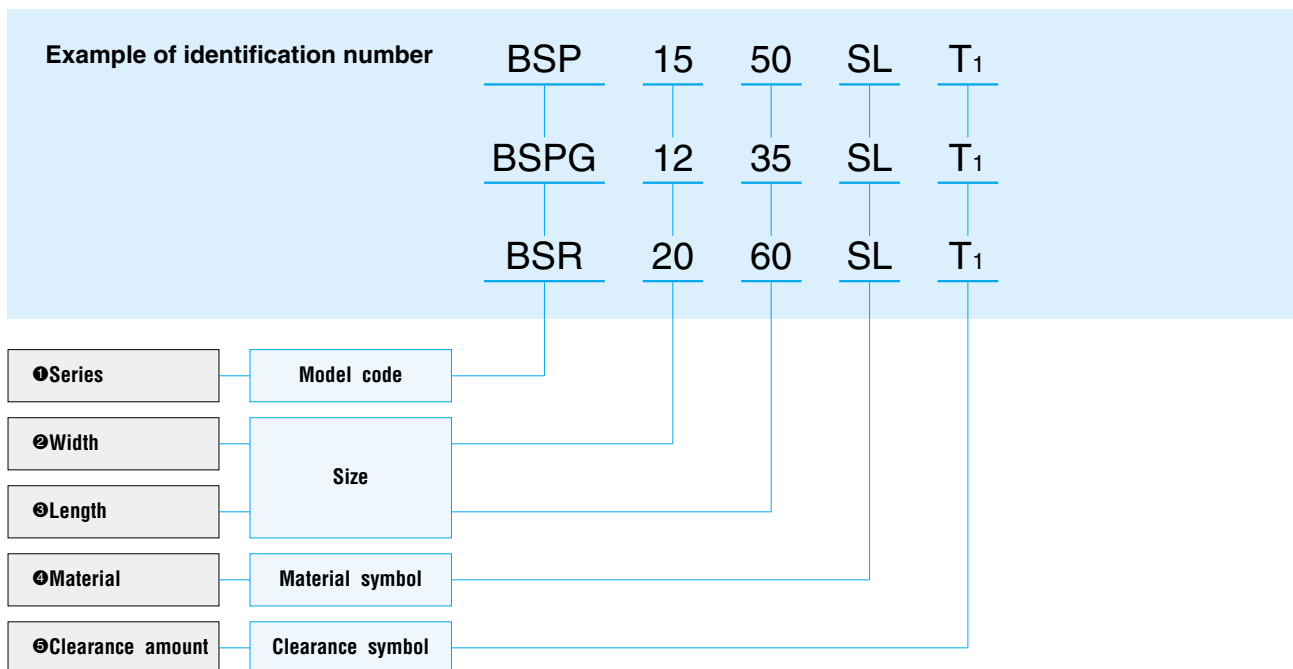

- ①Series**
Limited linear motion type : BSP
Built-in rack & pinion type : BSPG
Endless linear motion type : BSR
For available types and widths, see Table 1.
- ②Width**
Indicate the width in mm.

Table 1 Types and widths

Type Width	BSP	BSPG	BSR
7	○	—	—
10	○	—	—
12	—	○	○
15	○	○	○
20	○	○	○
25	○	○	○

- ③Length**
Indicate the length in mm.
- ④Material**
Stainless steel made : SL
Only stainless steel type “SL” is indicated.
- ⑤Clearance amount**
Standard : No symbol
T₁ clearance : T₁
For details of clearance amount, see Table 4.

Accuracy

The accuracy of Precision Linear Slide in operation is shown in Tables 2 and 3.

Table 2 Accuracy of BSP type and BSPG type

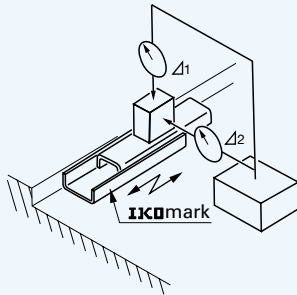

unit : μm

Stroke length mm		Parallelism in operation between bed center and mounting surface of table Δ_1	Parallelism in operation between bed center and reference mounting surface of table Δ_2
over	incl.		
—	18	3	6
18	30	4	8
30	50	5	10
50	80	6	12

Table 3 Accuracy of BSR type

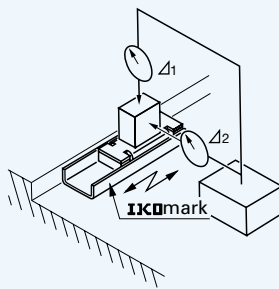

unit : μm

Stroke length mm		Parallelism in operation between slide unit center and mounting surface of track rail Δ_1	Parallelism in operation between slide unit center and reference mounting surface of track rail Δ_2
over	incl.		
—	18	3	6
18	30	4	8
30	50	5	10
50	80	6	12

Clearance

Internal clearances of Precision Linear Slide are shown in Table 4. Generally, standard clearance is recommended for applications requiring low friction. T1 clearance is generally suitable for applications requiring more accurate linear movement.

Table 4 Clearance

unit : μm

Clearance type and symbol	Clearance between raceways and balls
Standard (No symbol)	0 ~ +4
T1	-4 ~ 0

Load Rating

Basic dynamic load rating C

The basic dynamic load rating is defined as a constant load both in direction and magnitude under which a group of identical Precision Linear Slides are individually operated and where 90% of the slides in the group can travel 50×10^3 m free from material damage due to rolling contact fatigue.

Basic static load rating C_0

The basic static load rating is defined as a static load that gives a prescribed constant stress at the center of the contact area between a rolling element and raceway receiving the maximum load.

Life

The rating life of  Precision Linear Slide series is obtained from the following formula.

$$L = 50 \left(\frac{C}{P} \right)^3$$

$$L_h = \frac{10^6 L}{2S n_1 \times 60}$$

where, L : Rating life, 10^3 m

C : Basic dynamic load rating, N

P : Applied load, N

L_h : Rating life in hours, h

S : Stroke length, mm

n_1 : Number of strokes per minute, cpm

Precautions for Use

- 1 To obtain consistently high accuracy in operation, the applied load should not exceed 20% of the basic static load rating.
- 2 To maximize the accuracy of BSP or BSPG type, center the applied load over the table or bed. Allow enough additional stroke length to avoid reaching the maximum stroke length.
- 3 Unevenly applied loads and high fluctuating velocities may dislocate the position of the ball retainer in the BSP type. Therefore, it is recommended that the retainer is periodically repositioned to its proper location by cycling the BSP type over its full stroke length.
- 4 BSPG or BSR type is recommended when it is difficult to readjust the position of the retainer in the BSP type.
- 5 Operating temperature
The maximum operating temperature is 120°C, and continuous operation is possible at temperatures up to 100°C. If the operating temperature exceeds 100°C, consult  for further information.
- 6 Use Precision Linear Slide at speeds lower than 30m/min.
- 7 Precision Linear Slide does not incorporate a mechanical stopper. When over stroke is expected during the operation, prepare a stopper mechanism on the adjoining equipment.
- 8 In order to ensure smooth motion of BSP and BSR types, it is recommended to wash out rust preventive oil with a suitable cleaning agent, and reapply a high grade lubricating oil or grease to the raceways before running in.
- 9 The raceways and gear mechanism of BSPG type is smeared with Perfluoro Polyether grease, containing a volatile corrosion inhibiting film. In general use, the BSPG type can be used without any additional treatment if it is kept clean.

Precautions for Mounting

❶ The reference mounting surface of Precision Linear Slide is the side surface opposite to the  mark.

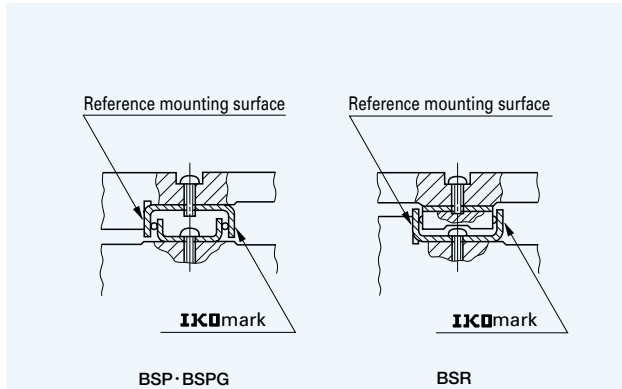



Fig. 1 Reference mounting surface

❷ When mounting Precision Linear Slide, the mounting bolts should not be inserted deeper than the maximum insertion depth shown in the dimension table.

❸ When mounting the BSP and BSPG types, the female threads in the table and bed are usually used. It can also be mounted with screws that are one size smaller than the female threads by inserting the screws through the female thread holes. BSP715SL~BSP740SL can not be mounted from inside of the table and bed.

❹ When mounting the track rail of BSR type, the female threads of the track rail are used. It can also be mounted with screws that are one size smaller than the female threads by inserting the screws through the female thread holes. BSR1530 SL and BSR2040SL can not be mounted from inside of the track rail.

When mounting BSR 1230 SL ~ BSR 1260 SL track rail with screws that are one size smaller than the female threads by inserting the screws through the female thread holes, consult .

❺ The accuracy of mating surface affects both accuracy and performance of Precision Linear Slides. Therefore, to obtain optimal accuracy during operation, the surface should be finished to as high accuracy as possible.

It is recommended to make a relieved fillet at the corner of the mating reference mounting surfaces as shown in Fig. 1. However, corner radius R_1 shown in Table 5 can also be used. Table 5 shows recommended shoulder height of the mating reference mounting surfaces.

Table 5 Shoulder height and corner radius of the mating reference mounting surfaces

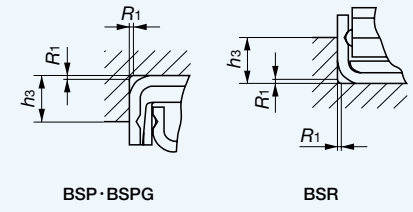

unit : mm

Model number			Shoulder height h_3	Corner radius R_1 (max.)
—	—	BSR 12··	2.5	0.5
BSP 7··	—	—	3	
BSP 10··	—	—	4	
—	BSPG 12··	—	4	
BSP 15··	BSPG 15··	BSR 15··	5	
BSP 20··	BSPG 20··	BSR 20··	6	
BSP 25··	BSPG 25··	BSR 25··		

❻ Tightening torque of mounting bolts affects the performance and accuracy of Precision Linear Slides. The limit of tightening torque depends on the material, rigidity, and finish of the mating surfaces. In general, a light tightening torque is used, and the recommended values are shown in Table 6. When vibration is expected to occur, it is recommended to use adhesive agent, etc. to secure the bolts.

Table 6 Recommended tightening torque of bolts

Bolt size	Tightening torque N·m
M2 ×0.4	0.064
M2.3×0.4	0.10
M2.6×0.45	0.15
M3 ×0.5	0.23

IKO Precision Linear Slide

Limited linear motion type : BSP

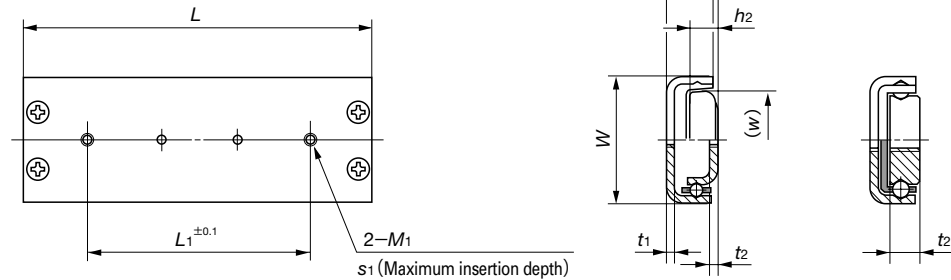

BSP 7

Model number	Mass (Ref.) g	Nominal dimensions mm				Mounting dimensions of table mm				
		W	H	L	Maximum stroke length	L ₁	M ₁	Maximum insertion depth S ₁	h ₁	t ₁
BSP 7 15 SL⁽¹⁾	2.1	7	4	15	9	5	M2	1	3.4	0.9
BSP 7 20 SL⁽¹⁾	2.8			20	9	10				
BSP 7 30 SL⁽¹⁾	4.2			30	18	20				
BSP 7 40 SL⁽¹⁾	5.6			40	23	30				
BSP 10 25 SL	6.2	10	6	25	15	15	M2.6	1.5	5.8	1.1
BSP 10 35 SL	8.8			35	26	25				
BSP 10 45 SL	11.3			45	38	35				
BSP 15 30 SL	11	15	8	30	22	14	M3	2.5	7	1.2
BSP 15 40 SL	14.7			40	24	24				
BSP 15 50 SL	18.4			50	32	34				
BSP 15 60 SL	22.1			60	40	40				
BSP 20 40 SL	23.7	20	10	40	22	24	M3	3.2	9	1.4
BSP 20 50 SL	29.7			50	28	34				
BSP 20 60 SL	35.7			60	34	40				
BSP 20 70 SL	41.7			70	40	45				
BSP 20 80 SL	47.6			80	53	50				
BSP 25 50 SL	37.6	25	10	50	26	34	M3	3.5	9	1.6
BSP 25 60 SL	45.3			60	32	40				
BSP 25 70 SL	52.9			70	40	45				
BSP 25 80 SL	60.5			80	51	50				
BSP 25 100 SL	75.8			100	63	60				

Note⁽¹⁾ : BSP 715 SL ~ BSP 740 SL can not be mounted from inside of the table and bed.

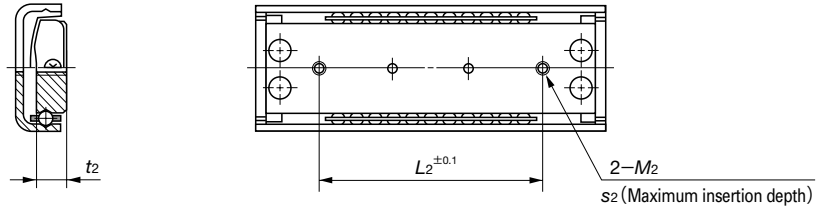

BSP 10

Mounting dimensions of bed mm						Basic dynamic load rating C N	Basic static load rating C ₀ N	Model number
w	L ₂	M ₂	Maximum insertion depth s ₂	h ₂	t ₂			
3.6	5	M2	2	—	2	80.6	41.8	BSP 7 15 SL⁽¹⁾
	10					115	69.6	BSP 7 20 SL⁽¹⁾
	20					146	97.5	BSP 7 30 SL⁽¹⁾
	30					174	125	BSP 7 40 SL⁽¹⁾
6.2	15	M2.6	2.7	3.7	2.7	293	155	BSP 10 25 SL
	25					342	193	BSP 10 35 SL
	35					389	232	BSP 10 45 SL
11.2	14	M3	3	4.5	1.2	339	193	BSP 15 30 SL
	24					471	309	BSP 15 40 SL
	34					551	387	BSP 15 50 SL
	40					626	464	BSP 15 60 SL
16	24	M3	3.5	6.2	1.4	623	384	BSP 20 40 SL
	34					743	493	BSP 20 50 SL
	40					855	603	BSP 20 60 SL
	45					961	713	BSP 20 70 SL
	50					1 010	768	BSP 20 80 SL
20.5	34	M3	3	5.7	1.6	743	493	BSP 25 50 SL
	40					855	603	BSP 25 60 SL
	45					961	713	BSP 25 70 SL
	50					1 010	768	BSP 25 80 SL
	60					1 210	987	BSP 25 100 SL

IKO Precision Linear Slide

Built-in rack & pinion type : BSPG

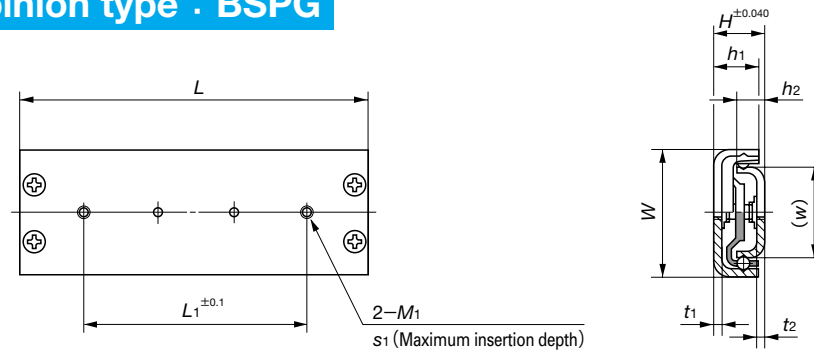

Model number	Mass (Ref.) g	Nominal dimensions mm				Mounting dimensions of table mm				
		W	H	L	Maximum stroke length	L ₁	M ₁	Maximum insertion depth S ₁	h ₁	t ₁
BSPG 12 25 SL	6.5	12	6	25	14	15	M2.6	2	5.2	1.2
BSPG 12 35 SL	9.0			35	24	24				
BSPG 12 45 SL	11.6			45	34	34				
BSPG 15 40 SL	15.8	15	8	40	24	24	M3	2.5	7	1.2
BSPG 15 50 SL	19.6			50	32	34				
BSPG 15 60 SL	23.5			60	40	40				
BSPG 20 40 SL	25.5	20	10	40	22	24	M3	3.2	9	1.4
BSPG 20 50 SL	31.8			50	28	34				
BSPG 20 60 SL	38.1			60	34	40				
BSPG 20 70 SL	44.4			70	40	45				
BSPG 20 80 SL	50.5			80	47	50				
BSPG 25 50 SL	40.3	25	10	50	26	34	M3	3.5	9	1.6
BSPG 25 60 SL	48.3			60	32	40				
BSPG 25 70 SL	56.2			70	38	45				
BSPG 25 80 SL	64.1			80	44	50				
BSPG 25 100 SL	80.0			100	56	60				

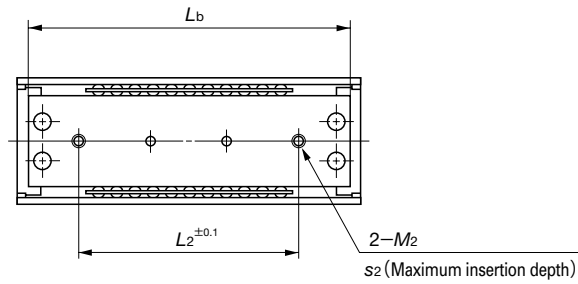

Mounting dimensions of bed mm							Basic dynamic load rating C N	Basic static load rating C ₀ N	Model number
L_b	w	L_2	M_2	Maximum insertion depth s_2	h_2	t_2			
23.6	7.6	15	M2.6	2	3	1	209	131	BSPG 12 25 SL
33.6		24					256	174	BSPG 12 35 SL
43.6		34					299	218	BSPG 12 45 SL
37	9.6	24	M3	3	4.5	1.2	471	309	BSPG 15 40 SL
47		34					551	387	BSPG 15 50 SL
57		40					626	464	BSPG 15 60 SL
37	13.8	24	M3	3.5	6.2	1.4	623	384	BSPG 20 40 SL
47		34					743	493	BSPG 20 50 SL
57		40					855	603	BSPG 20 60 SL
67		45					961	713	BSPG 20 70 SL
77		50					1 060	822	BSPG 20 80 SL
46	18.4	34	M3	3	5.7	1.6	743	493	BSPG 25 50 SL
56		40					855	603	BSPG 25 60 SL
66		45					961	713	BSPG 25 70 SL
76		50					1 060	822	BSPG 25 80 SL
96		60					1 250	1 040	BSPG 25 100 SL

IKO Precision Linear Slide

Endless linear motion type : BSR

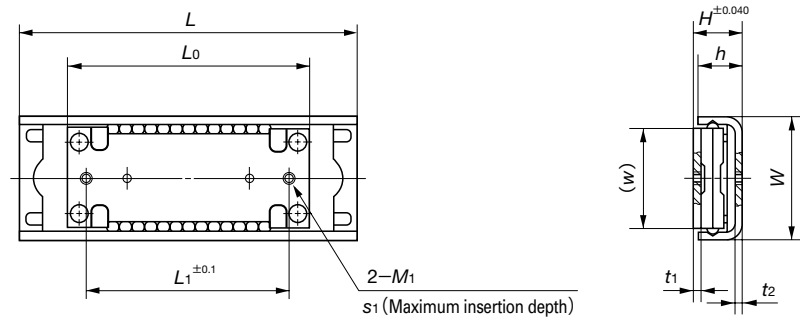

Model number	Mass (Ref.) g	Nominal dimensions mm				Mounting dimensions of slide unit mm				
		W	H	L	Maximum stroke length	w	L ₀	L ₁	M ₁	Maximum insertion depth S ₁
BSR 12 30 SL⁽¹⁾	5.8	12	4.5	30	13	9.8	21.5	15	M2	1.3
BSR 12 40 SL⁽¹⁾	7.0			40	23					
BSR 12 50 SL⁽¹⁾	8.2			50	33					
BSR 12 60 SL⁽¹⁾	9.3			60	43					
BSR 15 30 SL⁽²⁾	12.6	15	8	30	10	12.2	30	24	M3	1.8
BSR 15 40 SL	14.8			40	20					
BSR 15 50 SL	17.1			50	30					
BSR 15 60 SL	19.3			60	40					
BSR 20 40 SL⁽²⁾	27.6	20	10	40	12	16.8	40	32	M3	2.2
BSR 20 50 SL	31.1			50	22					
BSR 20 60 SL	34.6			60	32					
BSR 20 70 SL	38.1			70	42					
BSR 20 80 SL	41.6	25	10	80	52	21.4	50	42	M3	2.4
BSR 25 70 SL	53.8			70	33					
BSR 25 80 SL	58.4			80	43					
BSR 25 100 SL	67.4			100	63					

Note⁽¹⁾ : When mounting BSR 1230 SL ~ BSR 1260 SL track rail with screws that are one size smaller than the female threads by inserting the screws through the female thread holes, consult .

(²) : BSR 1530 SL and BSR 2040 SL can not be mounted from inside of the track rail.

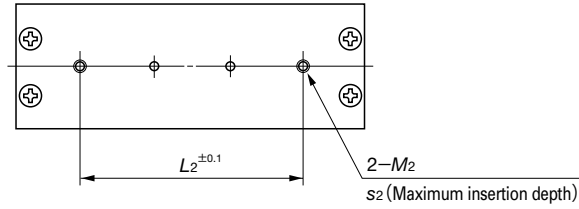

t_1	Mounting dimensions of track rail mm					Basic dynamic load rating C N	Basic static load rating C_0 N	Model number
	L_2	M_2	Maximum insertion depth s_2	h	t_2			
0.9	15	M2	1.6	4	0.9	183	139	BSR 12 30 SL⁽¹⁾
	20							BSR 12 40 SL⁽¹⁾
	34							BSR 12 50 SL⁽¹⁾
	40							BSR 12 60 SL⁽¹⁾
1	14	M3	3	7	1.2	466	309	BSR 15 30 SL⁽²⁾
	24							BSR 15 40 SL
	34							BSR 15 50 SL
	40							BSR 15 60 SL
1.4	24	M3	3.5	9	1.4	790	548	BSR 20 40 SL⁽²⁾
	34							BSR 20 50 SL
	40							BSR 20 60 SL
	45							BSR 20 70 SL
	50							BSR 20 80 SL
1.6	45	M3	3.5	9	1.6	1 000	768	BSR 25 70 SL
	50							BSR 25 80 SL
	60							BSR 25 100 SL



NIPPON THOMPSON CO., LTD.

Head office : 19-19 Takanawa 2-chome
Minato-ku, Tokyo 108-8586, Japan
Phone : Tokyo (03)3448-5850
Fax : (03)3447-7637
E-mail : ntt@ikonet.co.jp
URL : <http://www.ikont.co.jp/>
Plant : Gifu, Kamakura

IKO International, Inc.

- P.O. BOX 5897
91 Walsh Drive
Parsippany, NJ 07054
U.S.A.
Phone: (973)402-0254
Toll Free: 1-800-922-0337
Fax: (973)402-0441
E-mail: eco@ikonet.co.jp
- 500 East Thorndale Avenue
Wood Dale, IL 60191
U.S.A.
Phone: (630)766-6464
Toll Free: 1-800-323-6694
Fax: (630)766-6869
E-mail: mwo@ikonet.co.jp
- 20170 South Western Avenue
Torrance, CA 90501
U.S.A.
Phone: (310)609-3988
Toll Free: 1-800-252-3665
Fax: (310)609-3916
E-mail: wco@ikonet.co.jp
- 2150 Boggs Road, Suite 100
Duluth, GA 30096
U.S.A.
Phone: (770)418-1904
Toll Free: 1-800-874-6445
Fax: (770)418-9403
E-mail: seo@ikonet.co.jp
- 8105 N. Beltline Road
Suite 130, Irving, TX 75063
U.S.A.
Phone: (972)929-1515
Toll Free: 1-800-295-7886
Fax: (972)915-0060
E-mail: sw@ikonet.co.jp

Nippon Thompson Europe B.V.

- Sheffieldstraat 35-39
3047 AN Rotterdam
The Netherlands
Phone: 010-4626868
Fax: 010-4626099
E-mail: nte@ikonet.co.jp
- Mündelheimer Weg 56
40472 Düsseldorf
Germany
Phone: 0211-414061
Fax: 0211-427693
E-mail: ntd@ikonet.co.jp

Donaustauer Str. 200
93059 Regensburg
Germany
Phone: 0941-447737
Fax: 0941-447747
- 2 Vincent Avenue, Crownhill
Milton Keynes Bucks MK8 OAB
United Kingdom
Phone: 01908-566144
Fax: 01908-565458
E-mail: sales@iko.co.uk
- Autovia Madrid-Barcelona, Km. 43,700
Polig. Ind. AIDA, A-8, Ofic. 2, 1^a
19200-Azuqueca de Henares
Guadalajara, Spain
Phone: 949-263390
Fax: 949-263113
E-mail: nts@ikonet.co.jp
- Roissypole Le Dôme
2 rue de La Haye
BP 10950 Tremblay en France
95733 Roissy C. D. G. Cedex
France
Phone: 01-48165739
Fax: 01-48165746
E-mail: ntf@ikonet.co.jp

Although all data in this catalog has been carefully compiled to make the information as complete as possible, NIPPON THOMPSON CO., LTD. shall not be liable for any damages whatsoever, direct or indirect, based upon any information in this catalog. NIPPON THOMPSON CO., LTD. makes no warranty, either express or implied, including the implied warranty of merchantability or fitness for a particular purpose.